

## Various Elements of Energy Conservation

	Water supply	Fuel	Boilers	Steam	Steam-using equipment	Condensate
Equipment		<ul style="list-style-type: none"> <li>- Fuel type (solid, liquid or gas)</li> <li>Boiler service life</li> <li>Efficiency</li> <li>Boiler efficiency loss due to soot accumulation and soot blow</li> <li>Pollution control</li> <li>Storage and transportation</li> <li>Safety</li> </ul>	<ul style="list-style-type: none"> <li>- Type</li> <li>- Capacity and number of units</li> <li>- Load fluctuation</li> <li>- Efficiency of boiler proper</li> <li>- Waste heat recovery</li> <li>- Environmentally friendliness</li> <li>- Blowdown steam heat recovery</li> <li>- Blower motor speed control</li> <li>- Operation method</li> <li>Combustion control</li> <li>- Labor costs</li> <li>- Amount of blowdown water</li> </ul>	<ul style="list-style-type: none"> <li>- Minimization of heat dissipation</li> <li>Heat insulation and leak prevention</li> <li>- Dryness of steam</li> <li>- Condensate discharge</li> <li>Steam traps</li> <li>- Piping slope</li> <li>- Steam pressure</li> <li>Selection of supply pressure</li> </ul>	<ul style="list-style-type: none"> <li>- Condensate discharge</li> <li>Steam traps</li> <li>- Steam pressure</li> <li>Selection of utilization pressure</li> <li>- Evening out of steam load</li> </ul>	<ul style="list-style-type: none"> <li>- Condensate recovery</li> </ul>
Operation control	<ul style="list-style-type: none"> <li>- Water quality control</li> </ul>					

## Kinds and features of boilers

Item \ Kind	Water tube boiler	Flue and smoke tube boiler	Small once-through boiler
Capacity (t/h)	3 ~ 300 (Large boiler available for power generation)	1 ~ 30	0.1 ~ 3
Steam pressure (kg/cm <sup>2</sup> )	1 ~ 200	1 ~ 20	1 ~ 10
Feed water circulation method	Natural and forced	Natural	Once-through
Holding water amount	30 to 40% based on amount of evaporation (4 tons in the case of 10-ton boiler)	100 to 120% based on amount of evaporation (12 tons in the case of 10-ton boiler)	10 to 20% based on amount of evaporation (110 kg in the case of 1-ton boiler)
Steam generating time (min)	10 ~ 20	20 ~ 30	5
Water quality control	Difficult (more difficult at higher pressure)	Relatively easy	Difficult
Adaptation to load variation	Relatively good	Good	Poor (good if control of plural boilers is adopted.)
Main body life	10 to 30 years	10 to 20 years	10 to 15 years
Boiler efficiency (%)	85 ~ 90	85 ~ 90	80 ~ 90

# 1. Water tube boiler

## Appearance

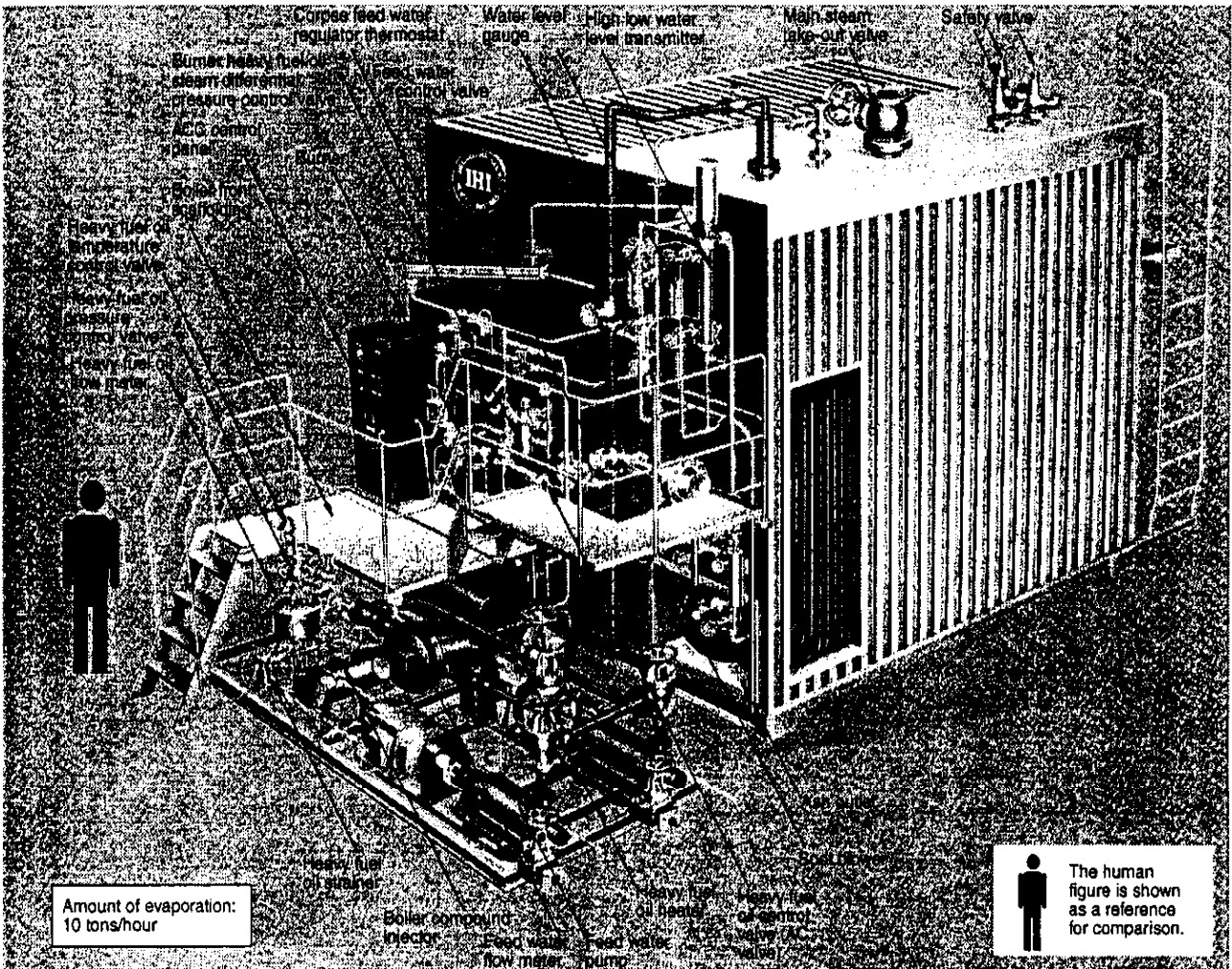

## Structure

- ① Heat insulating material
- ② Furnace side wall tubes
- ③ Steam drum
- ④ Deaerator
- ⑤ Upper connecting tube
- ⑥ Main steam nozzle
- ⑦ Furnace rear wall upper header
- ⑧ Baffle plate
- ⑨ Steam separator
- ⑩ Front casing
- ⑪ Burner portion refractory
- ⑫ Baffle tube
- ⑬ Water drum
- ⑭ Base
- ⑮ Steam tubes
- ⑯ Steam tube portion side wall tubes
- ⑰ Outer casing (keystone plate)

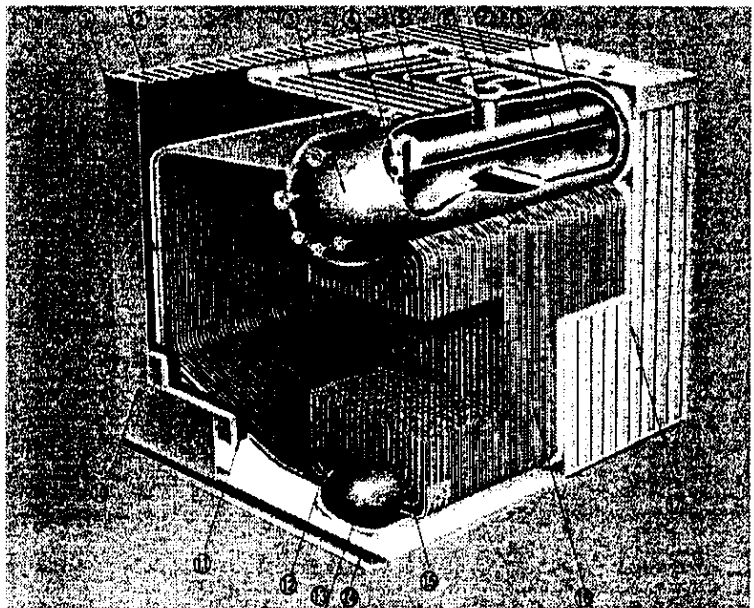

## Flue and smoke tube boiler

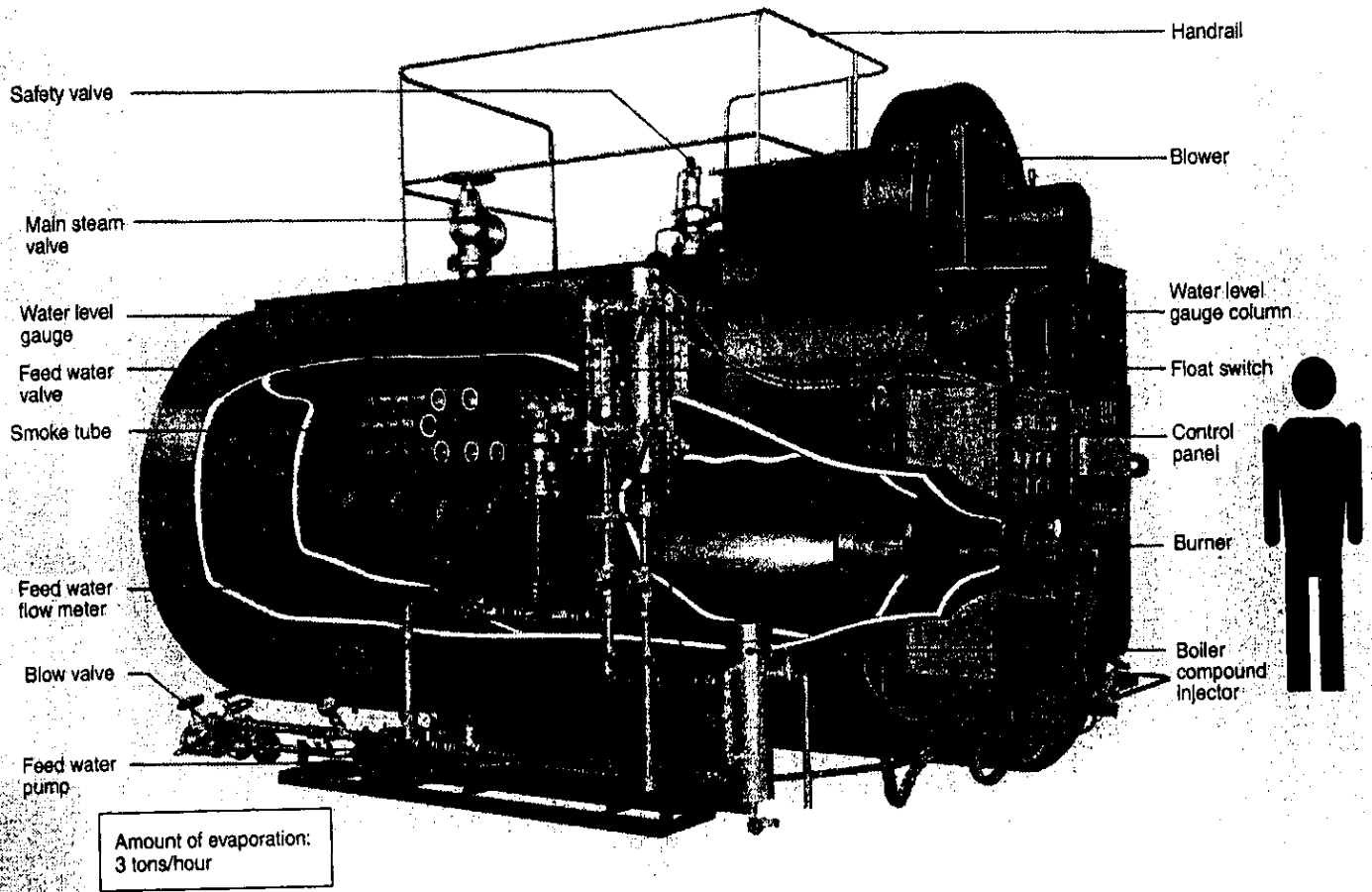

## Small once-through boiler

Amount of evaporation: 2 tons/hour

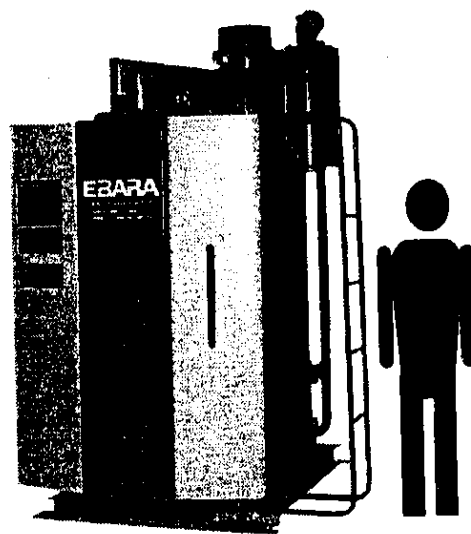

## Combustion theory

### Calorific value of fuel

**Higher calorific value Hh** Calorific value with the latent heat of condensation of steam in the combustion gas taken into account.

The calorific value measured by a calorimeter is a higher calorific value.

**Lower calorific value HL** Calorific value with the latent heat of condensation of steam in the combustion gas not taken into account

In the case of gas fuel,

$$HL = Hh - 4.70 \cdot (H_2 + 2CH_4 + 2C_2H_4)$$

### Theoretical amount of air

### Excess air factor

### Theoretical amount of dry exhaust gas

## Calculation of amount of air and amount of exhaust gas

### 1. Calculation from fuel gas composition

Fuel gas composition (example) V%

CH <sub>4</sub>	88	CH <sub>4</sub> + 2O <sub>2</sub> → CO <sub>2</sub> + 2H <sub>2</sub> O
C <sub>2</sub> H <sub>6</sub>	5	C <sub>2</sub> H <sub>6</sub> + 7/2 · O <sub>2</sub> → 2 · CO <sub>2</sub> + 3 · H <sub>2</sub> O
C <sub>3</sub> H <sub>8</sub>	5	C <sub>3</sub> H <sub>8</sub> + 5 · O <sub>2</sub> → 3 · CO <sub>2</sub> + 4 · H <sub>2</sub> O
C <sub>4</sub> H <sub>10</sub>	2	C <sub>4</sub> H <sub>10</sub> + 13/2 · O <sub>2</sub> → 4 · CO <sub>2</sub> + 5 · H <sub>2</sub> O

For each component		
Necessary multiple	Product multiple	
O <sub>2</sub>	CO <sub>2</sub>	H <sub>2</sub> O
2	1	2
3.5	2	3
5	3	4
6.5	4	5

Theoretical amount of oxygen

$$VO_2 = 2 \cdot CH_4 + 3.5 \cdot C_2H_6 + 5 \cdot C_3H_8 + 6.5 \cdot C_4H_{10} \quad m^3/(\text{per } 1 \text{ m}^3 \text{ of fuel})$$

$$2 \times 0.88 + 3.5 \times 0.05 + 5 \times 0.05 + 6.5 \times 0.02 = 2.315 \text{ m}^3/\text{m}^3$$

Theoretical amount of air

$$N_2 : O_2 = 79 : 21, \text{ hence } V_{aO} = VO_2/0.21$$

$$2.315/0.21 = 11.024 \text{ m}^3/\text{m}^3$$

Theoretical amount of dry exhaust gas

$$V_{gO} = CH_4 + 2 \cdot C_2H_6 + 3 \cdot C_3H_8 + 4 \cdot C_4H_{10} + 0.79 \cdot V_{aO}$$

$$0.88 + 2 \times 0.05 + 3 \times 0.05 + 4 \times 0.02 + 0.79 \times 11.02 = 9.916 \text{ m}^3/\text{m}^3$$

To obtain the excess air factor from the O<sub>2</sub> concentration of exhaust gas:

Excess air factor

$$m = 21/(21 - O_2) \quad O_2 \quad O_2 \text{ concentration of dry exhaust gas}$$

If O<sub>2</sub> = 3.5%, then  $m = 1.2$ .

Actual amount of dry exhaust gas

$$V_{gd} = V_{gO} + (m - 1) \cdot V_{aO}$$

$$9.916 + (1.2 - 1) \times 11.02 = 12.12 \text{ m}^3/\text{m}^3$$

Actual amount of wet exhaust gas

$$V_{gw} = V_{gd} + 2 \cdot CH_4 + 3 \cdot C_2H_6 + 4 \cdot C_3H_8 + 5 \cdot C_4H_{10}$$

$$12.12 + 2 \times 0.88 + 3 \times 0.05 + 4 \times 0.05 + 5 \times 0.02 = 14.33 \text{ m}^3/\text{m}^3$$

2. Approximation from the calorific value of fuel

Theoretical amount of air

$$V_{aO} = 2.68 \times HL/10000 \quad m^3/m^3 \quad (SI)$$

$$(V_{aO} = 11.2 \times HL/10000) \quad (kcal)$$

$$HL = 41400 \text{ kJ/m}^3N,$$

$$2.68 \times 41400/10000 \quad 11.095 \quad m^3/m^3$$

Actual amount of wet exhaust gas

$$V_{gw} = (2.93 + 2.68 \cdot (m - 1)) \times HL/10000$$

$$(V_{gw} = (12.25 + 11.20 \cdot (m - 1)) \times HL/10000)$$

$$m = 1.2,$$

assuming

$$(2.93 + 2.68 \times (1.2 - 1)) \times 41400/10000 \quad 14.349 \quad m^3/m^3$$

3. Generation of CO<sub>2</sub> and H<sub>2</sub>O

$$CO_2 \quad CH_4 + 2 \cdot C_2H_6 + 3 \cdot C_3H_8 + 4 \cdot C_4H_{10}$$

$$0.88 + 2 \times 0.05 + 3 \times 0.05 + 4 \times 0.02 \quad 1.21 \quad m^3/m^3$$

$$\text{The concentration in the actual exhaust gas is } 1.21/14.33. \quad 8.4\%$$

$$H_2O \quad 2 \cdot CH_4 + 3 \cdot C_2H_6 + 4 \cdot C_3H_8 + 5 \cdot C_4H_{10}$$

$$2 \times 0.88 + 3 \times 0.05 + 4 \times 0.05 + 5 \times 0.02 \quad 2.21 \quad m^3/m^3$$

$$\text{The concentration in the actual exhaust gas is } 2.21/14.33. \quad 15.4\%$$

## Boiler efficiency

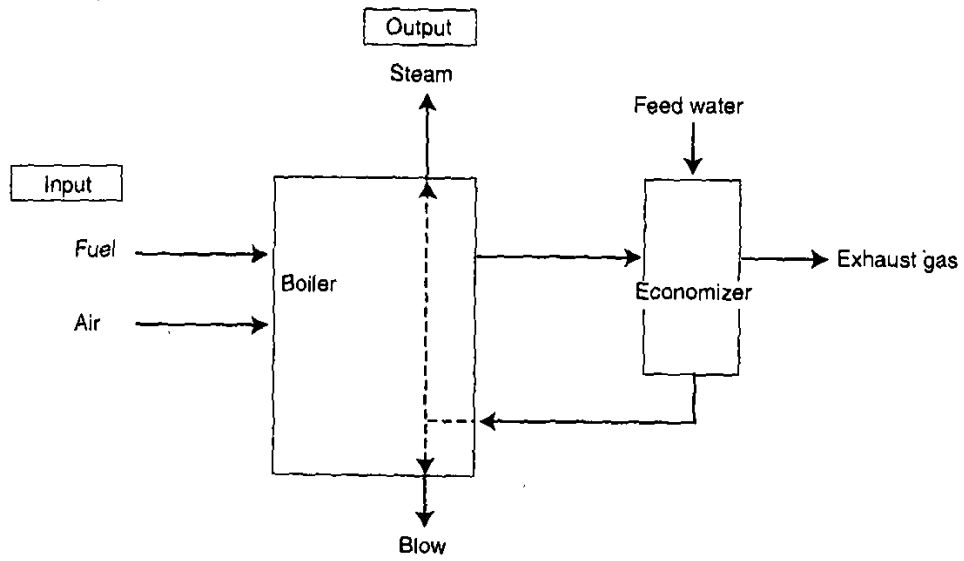

Boiler efficiency (%)

$$= \frac{\text{Heat output}}{\text{Heat input}} \times 100$$

$$= \frac{\text{Generated steam heat} - \text{Feed water heat}}{\text{Amount of fuel} \times \text{Lower calorific value of fuel}}$$

$$= \frac{\{(\text{Amount of feed water}) - (\text{Amount of blow})\} \times \{(\text{Enthalpy of steam}) - (\text{Enthalpy of feed water})\}}{\text{Amount of fuel} \times \text{Lower calorific value of fuel}}$$

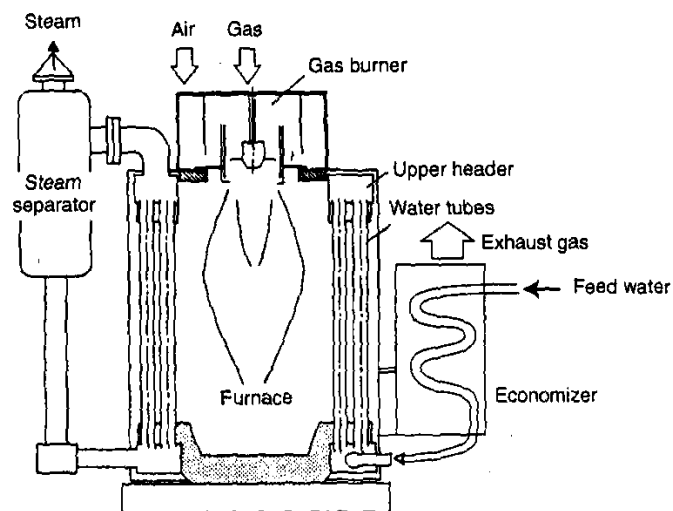

Structure of small once-through boiler



## An exercise of heat balance

### 1. Theory of heat balance

- Structure of once-through boiler
- JIS specifications of heat balance
  - Heat input/output method
  - Exhaust gas loss method
- Combustion theory

### 2. An exercise of measurement

- Purpose: To obtain boiler efficiencies under different operation conditions, for understanding the operation conditions for operating at a higher efficiency.

- Boiler specifications

Model:	KF-1500 GES (small once-through boiler produced by Kawasaki Reinetsu Kogyo)	
Equivalent evaporation:	1,410 kg/h	
Heat output:	884 kW	
Heating surface area:	9.8 m <sup>2</sup>	
Maximum pressure:	0.98 MPa	
Fuel used:	.13 A	Gas supply pressure: 18.6 kPa
Fuel consumption:	80 Nm <sup>3</sup> /h	

### 3. Operation conditions

- |                     |                             |
|---------------------|-----------------------------|
| ① Boiler load: High | Excess air factor (m): Low  |
| ② Boiler load: High | Excess air factor (m): High |
| ③ Boiler load: Low  | Excess air factor (m): Low  |

### 4. Cautions

- (1) Operate the boiler under the respective operation conditions, and record data at 5 minutes (A), 20 minutes (B) and 35 minutes (C) after start of operation, to calculate the boiler efficiencies of A~C and B~C.
- (2) JIS specifies that the measurement shall be carried out without blow, but since this exercise is intended to measure the efficiency of an actually running boiler, the measurement will be carried out with blow.
- (3) For obtaining a more accurate efficiency, it is necessary to compare the efficiency measured according to the heat input/output method and the efficiency measured according to the exhaust gas loss method. However, in this exercise, efficiencies will be measured according to the exhaust gas method only.

(4) Properties of the fuel (13A gas) are as follows:

Components	CH <sub>4</sub> .....	88.5%
	C <sub>2</sub> H <sub>6</sub> .....	4.6%
	C <sub>3</sub> H <sub>8</sub> .....	5.4%
	C <sub>4</sub> H <sub>10</sub> .....	1.5%
Gross calorific value .....		46.047 MJ/m <sup>3</sup>
Lower calorific value .....		41.609 MJ/m <sup>3</sup>
Theoretical amount of air .....		10.95 m <sup>3</sup> /m <sup>3</sup>
Combustion products	CO <sub>2</sub> .....	1.199 m <sup>3</sup>
	H <sub>2</sub> O .....	2.199 m <sup>3</sup>
	N <sub>2</sub> .....	8.647 m <sup>3</sup>

- (5) Since the boiler is for exercises, many meters are installed for measurement of various data. So, do not make any mistake in identifying the respective meters.
- (6) Find the specific gravity of water and the enthalpies of feed water and steam from the saturated steam table.  
In this exercise, the dryness of generated steam is assumed to be 1.
- (7) Be careful of the hot portions of the boiler, lest you should be burnt.

## Boiler efficiencies according to the heat input/output method

Each \* mark indicates a measured value.

Date of measurement \_\_\_\_\_

				A	B	C
Measuring time	Unit					
Boiler load factor	%					
* Feed water temperature (inlet of economizer)	°C					
* Feed water temperature (outlet of economizer)	°C					
Specific gravity of water						
* Amount of feed water (reading of flow meter)	L					
Amount of feed water	L/H					
Amount of feed water	kg/H	E				
Enthalpy of feed water	kJ/kg	iw				
* Drum steam pressure	MPa					
Enthalpy of steam	kJ/kg	i"				

* Fuel gas temperature	°C	t				
* Fuel gas pressure	kPa	p				
* Amount of fuel (reading of flow meter)	m <sup>3</sup>					
Amount of fuel	m <sup>3</sup> /H	b				
Amount of fuel	Nm <sup>3</sup> /H	B				
Lower calorific value of gas	kJ/Nm <sup>3</sup>	HI				
* Exhaust gas temperature (outlet of boiler)	°C					
* Exhaust gas temperature (outlet of economizer)	°C					
* Oxygen concentration of exhaust gas	%					
Excess air factor		m				
* Outside air temperature (intake temperature)	°C					

* (Blow temperature)	°C					
Specific gravity of blow						
* Amount of blow (reading of flow meter)	L					
Amount of blow	L/H					
Amount of blow	kg/H	M				
Enthalpy of blow	kJ/kg	im				

Boiler efficiency	%	η <sub>b</sub>				
-------------------	---	----------------	--	--	--	--

Gas flow rate correction formula 
$$B = \frac{101.35 + p}{101.325} \times \frac{273}{273 + t} \times b$$

Calculation of boiler efficiency 
$$\eta_b = \frac{(E - M) \times (i'' - iw)}{B \times HI} \times 100\%$$

## Boiler efficiencies according to the heat input/output method

Each ★ mark indicates a measured value.

Date of measurement

			A	B	C
Measuring time	Unit		14'20"30	14'59"40	
Boiler load factor	%			99	⑫
★ Feed water temperature (inlet of economizer)	°C		19	19	
★ Feed water temperature (outlet of economizer)	°C		56	57	
Specific gravity of water	kg/L			0.9983	①
★ Amount of feed water (reading of flow meter)	L		8900	9750	
Amount of feed water	L/H			1302	②
Amount of feed water	kg/H	E		1299.8	③
Enthalpy of feed water	kJ/kg	iw		83.36	④
★ Drum steam pressure	MPa		0.67	0.67	
Enthalpy of steam	kJ/kg	i"		2.766	⑤

★ Fuel gas temperature	°C	t	25.1	22.9	
★ Fuel gas pressure	kPa	p	20	21	
★ Amount of fuel (reading of flow meter)	m <sup>3</sup>		18442.05	18491.23	
Amount of fuel	m <sup>3</sup> /H	b		75.34	⑥
Amount of fuel	Nm <sup>3</sup> /H	B		83.26	⑦
Lower calorific value of gas	kJ/Nm <sup>3</sup>	HI		41609	
★ Exhaust gas temperature (outlet of boiler)	°C		180	185	
★ Exhaust gas temperature (outlet of economizer)	°C		100	101	
★ Oxygen concentration of exhaust gas	%		4.0	4.0	
Excess air factor		m		1.24	⑬
★ Outside air temperature (intake temperature)	°C		29	29	

★ (Blow temperature)	°C			(100)	
Specific gravity of blow	kg/L			0.9581	⑧
★ Amount of blow (reading of flow meter)	L		2085 × 0.25	2413 × 0.25	
Amount of blow	L/H			125.6	⑨
Amount of blow	kg/H	M		120.3	⑩
Enthalpy of blow	kJ/kg	im		—	

Boiler efficiency	%	η <sub>b</sub>		91.3	⑪
-------------------	---	----------------	--	------	---

Gas flow rate correction formula 
$$B = \frac{101.35 + p}{101.325} \times \frac{273}{273 + t} \times b$$

Calculation of boiler efficiency 
$$\eta_b = \frac{(E - M) \times (i'' - iw)}{B \times HI} \times 100\%$$

### Calculation of boiler efficiency

Specific gravity (from the steam table)  
19°C  $0.0010017 \text{ m}^3/\text{kg} \Rightarrow 0.9983 \text{ kg}/\ell$  ①

Amount of feed water

$$(9750 - 8900) \times \frac{3600}{2350} = 1.302 \text{ } \ell/\text{h} \quad \text{②}$$

$$1302 \times 0.9983 = 1299.8 \text{ kg}/\text{h} \quad \text{③}$$

Enthalpy of feed water (from the steam table)  $83.36 \text{ kJ}/\text{kg}$  ④

Enthalpy of steam

$$0.67 \text{ MPa (gauge pressure)} + 0.1 \text{ MPa} = 0.77 \text{ MPa}$$
$$\text{From the steam table} \quad 2766 \text{ kJ}/\text{kg} \quad \text{⑤}$$

Amount of fuel

$$18491.23 - 18442.05 = 49.18$$

$$49.18 \times \frac{3600}{2350} = 75.34 \text{ m}^3/\text{h} \quad \text{⑥}$$

$$\frac{101.325 + 20.5}{101.325} \times \frac{273}{273 + 24} \times 75.34 = 83.26 \text{ Nm}^3/\text{h} \quad \text{⑦}$$

Blow temperature is assumed to be 100°C.

Specific gravity of blow  $0.0010437 \text{ m}^3/\text{kg} \Rightarrow 0.9581 \text{ kg}/\ell$  ⑧

Amount of blow

$$82 \times \frac{3600}{2350} = 125.6 \text{ } \ell/\text{h} \quad \text{⑨}$$

$$125.6 \times 0.9581 = 120.3 \text{ kg}/\text{h} \quad \text{⑩}$$

$$\eta_b = \frac{(1299.8 - 120.3) \times (2766 - 83.36)}{83.26 \times 41609} \times 100$$
$$= 91.3\% \quad \text{⑪}$$

### Calculation of excess air factor

O<sub>2</sub> concentration of exhaust gas (based on dry gas) 4%

$$m = \frac{21}{21 - 4} = 1.24 \quad \text{⑫}$$

### Calculation of boiler load factor

$$\frac{(1299.8 - 120.3) \times (2766 - 83.36)}{884 \times 860 \times 4.1868} \times 100 = 99\% \quad \text{⑬}$$

## Locations of meters

No.	Measuring instrument	Unit of measurement	Place of installation, etc.
①	Economizer output pressure	kPa	Left side face of boiler
②	Boiler output pressure	kPa	↑
③	Furnace inner pressure	kPa	↑
④	Air box pressure	kPa	↑
⑤	Exhaust gas oxygen concentration (dry gas)	%	↑
⑥	Economizer inlet feed water temperature	°C	↑
⑦	Economizer outlet feed water temperature	°C	↑
⑧	Steam temperature	°C	↑
⑨	Supply air temperature	°C	↑
⑩	Boiler outlet exhaust gas temperature	°C	↑
⑪	Economizer outlet exhaust gas temperature	°C	↑
⑫	Gas flow rate	m <sup>3</sup> /h	↑
⑬	Exhaust gas oxygen concentration meter (wet gas)	%	↑
⑭	Feed water flow meter	L	Rear of boiler Take care of window frame value and pointer value.
⑮	Blow flow meter	L, L/h	Rear of boiler Take care of integrated value (x 0.25L).
⑯	Turbine type gas flow meter	m <sup>3</sup> /h, kPa, °C	Right-hand rear of boiler
⑰	Positive displacement gas flow meter	m <sup>3</sup> /h	↑
⑱	Steam pressure gauge	MPa	Front of boiler

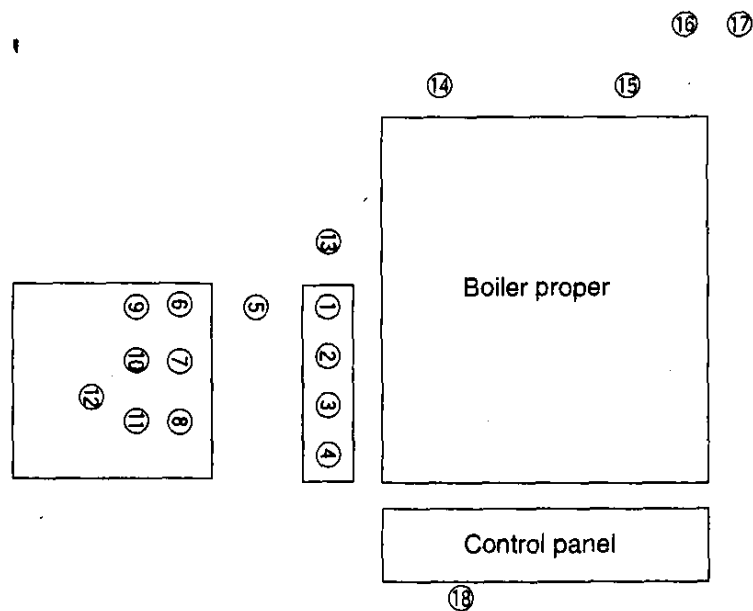

Data sheet [1]

Saturated steam table (in reference to temperature) [SI]

Temperature		Saturated pressure	Specific volume [m <sup>3</sup> /kg]		Specific enthalpy [kJ/kg]		
t [°C]	T [K]	Ps [MPa]	v'	v''	h'	h''	r = h'' - h'T
12	285.15	0.001 401 4	0.001 000 4	93.84	50.38	2 523.6	2 473.2
14	287.15	0.001 597 3	0.001 001 7	82.90	58.75	2 527.2	2 468.5
16	289.15	0.001 816 8	0.001 001 0	73.38	67.13	2 530.9	2 463.8
18	291.15	0.002 062	0.001 001 3	65.09	75.50	2 534.5	2 459.0
20	293.15	0.002 337	0.001 001 7	57.84	83.86	2 538.2	2 454.3
22	295.15	0.002 642	0.001 002 2	51.49	92.23	2 541.8	2 449.6
24	297.15	0.002 982	0.001 002 6	45.93	100.59	2 545.5	2 444.9
26	299.15	0.003 360	0.001 003 2	41.03	108.95	2 549.1	2 440.2
28	301.15	0.003 778	0.001 003 7	36.73	117.31	2 552.7	2 435.4
30	303.15	0.004 241	0.001 004 3	32.93	125.66	2 556.4	2 430.7
32	305.15	0.004 753	0.001 004 9	29.57	134.02	2 560.0	2 425.9
34	307.15	0.005 318	0.001 005 6	26.60	142.38	2 563.6	2 421.2
36	309.15	0.005 940	0.001 006 3	23.97	150.74	2 567.2	2 416.4
38	311.15	0.006 624	0.001 007 0	21.63	159.09	2 570.8	2 411.7
40	313.15	0.007 375	0.001 007 8	19.55	167.45	2 574.4	2 406.9
80	353.15	0.047 36	0.001 029 2	3.409	334.92	2 643.8	2 308.8
85	358.15	0.057 80	0.001 032 6	2.829	355.92	2 652.0	2 296.5
90	363.15	0.070 11	0.001 036 1	2.361	376.94	2 660.1	2 283.2
95	368.15	0.084 53	0.001 039 9	1.982	397.99	2 668.1	2 270.2
100	373.15	0.101 33	0.001 043 7	1.673	419.06	2 676.0	2 256.9
110	383.15	0.413 27	0.001 051 9	1.210	461.32	2 691.3	2 230.0
120	393.15	0.198 54	0.001 060 6	0.891 5	503.72	2 706.0	2 202.2
130	403.15	0.270 13	0.001 070 0	0.668 1	546.31	2 719.9	2 173.6
140	413.15	0.361 4	0.001 080 1	0.508 5	589.10	2 733.1	2 144.0
150	423.15	0.476.0	0.001 090 8	0.392 4	632.15	2 745.4	2 113.2

Saturated steam table (in reference to pressure) [SI]

Pressure	Saturated temperature		Specific volume [m <sup>3</sup> /kg]		Specific enthalpy [kJ/kg]		
P [MPa]	ts [°C]	ts [K]	v'	v''	h'	h''	r = h'' - h'T
0.2	120.23	393.38	0.001 060 8	0.885 4	504.70	2 706.3	2 201.6
0.3	133.54	406.69	0.001 073 5	0.605 6	561.43	2 724.7	2 163.2
0.4	143.62	416.77	0.001 083 9	0.462 2	604.67	2 737.6	2 133.0
0.5	151.84	424.99	0.001 092 8	0.374 7	640.12	2 747.5	2 107.4
0.6	158.84	431.99	0.001 100 9	0.315 5	670.42	2 755.5	2 085.0
0.7	164.96	438.11	0.001 108 2	0.272 7	697.06	2 762.0	2 064.9
0.8	170.41	443.56	0.001 115 0	0.240 3	720.94	2 767.5	2 046.5
0.9	175.36	448.51	0.001 121 3	0.214 8	724.64	2 772.1	2 029.5
1.0	179.88	453.03	0.001 127 4	0.194 3	762.61	2 776.2	2 013.6
1.2	187.96	461.11	0.001 138 6	0.163 2	798.43	2 782.7	1 984.3
1.4	195.04	468.19	0.001 148 9	0.140 7	830.08	2 787.8	1 957.7
1.5	198.29	471.44	0.001 153 9	0.131 7	844.67	2 789.9	1 945.2
1.6	201.37	474.52	0.001 158 6	0.123 7	858.56	2 791.7	1 933.2
1.8	207.11	480.26	0.001 167 8	0.110 3	884.58	2 794.8	1 910.3

# **The Energy Saving Technology in Boiler**

Tokyo Gas



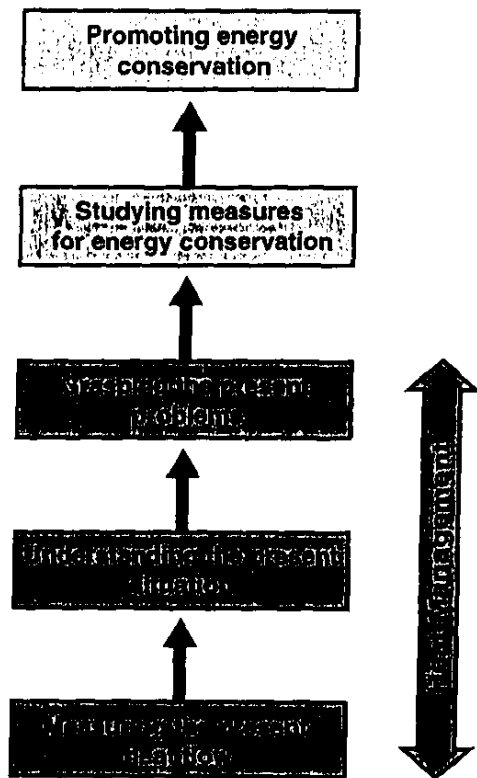

1

- STEP 1** Measuring the heat flow and defining the present usage of heat for each boiler
- STEP 2** Grasping each type of heat loss and studying improvement measures
- STEP 3** Studying concrete energy conservation measures and promoting energy conservation

2

## Contents

1. Heat management methods
2. Energy conservation for boilers
3. Energy conservation for steam systems
4. Conclusion

3

## 1. Heat management methods

- ① Heat flow
- ② Measurement points and measurement method
- ③ Calculation of heat efficiency

4

## Boiler heat fl

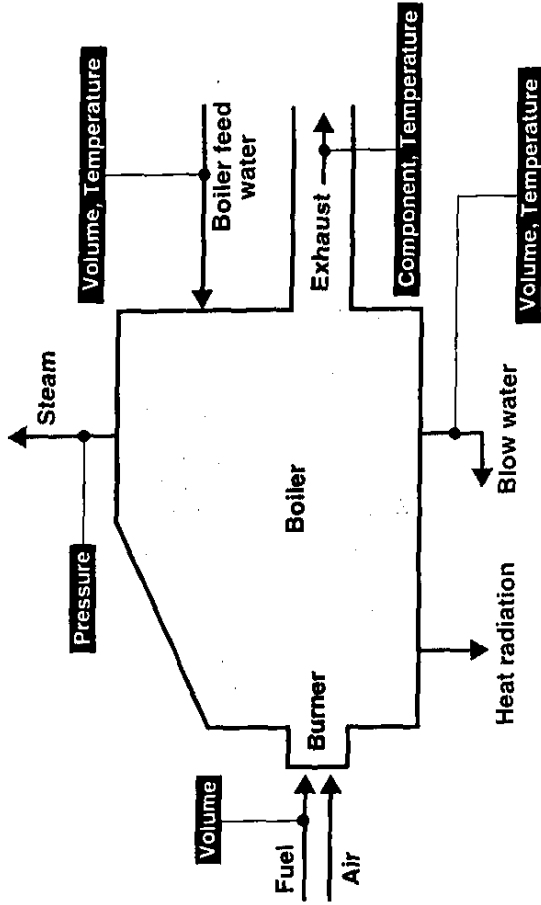

## Measurement

Volume of fuel consumption (ℓ/h)

Feed water supply volume (ℓ/h),  
Feed water supply temp.(°C)

Steam pressure (kg/cm<sup>2</sup>)

Exhaust component(%),  
Exhaust temp.(°C)

Blow water volume (ℓ/h),  
Blow water temp.(°C)



## Calculation of heat efficiency

Input and output heat method

$$\begin{aligned} \text{Boiler efficiency } E (\%) &= \frac{\text{Steam generated heat volume } Q_s \text{ (kcal)}}{\text{Fuel combustion heat volume } Q_f \text{ (kcal)}} \times 100 \\ &= \frac{W \times (h_s - h_w)}{F \times H_l} \times 100 \end{aligned}$$

W : Generated steam volume kg  
 h<sub>s</sub> : Enthalpy of steam kcal/kg  
 h<sub>w</sub> : Enthalpy of water supply kcal/kg  
 F : Volume of fuel ℓ  
 H<sub>l</sub> : Low calorific value kcal/ℓ

Heat loss method

$$\text{Boiler efficiency } E (\%) = 100 - (\text{Total heat loss})$$

$$100 - (\ell e + \ell r + \ell o)$$

$\ell e$ : Exhaust heat loss (%)  
 $\ell r$ : Furnace body heat radiation loss (%)  
 $\ell o$ : Percentage of other heat losses (%)

④

**2. Energy conservation for boilers**

- ① Reduction of exhaust heat loss
- ② Improvement of furnace body heat radiation loss
- ③ Reduction of other heat losses

④

**Exhaust heat loss (%)**

LSC heavy oil		O <sub>2</sub> %	CO <sub>2</sub> %	100°C	200°C	300°C	400°C	500°C	600°C
m									
1.0		0.0	15.6	3.89	7.88	11.98	16.20	20.52	24.96
1.1		2.0	14.1	4.24	8.58	13.03	17.61	22.31	27.13
1.2		3.7	12.9	4.58	9.27	14.08	19.02	24.10	29.29
1.3		5.1	11.9	4.93	9.97	15.13	20.44	25.88	31.46
1.4		6.3	11.0	5.27	10.66	16.18	21.85	27.67	33.62
1.5		7.3	10.2	5.62	11.36	17.24	23.27	29.45	35.79
1.6		8.2	9.5	5.96	12.05	18.29	24.68	31.24	37.95
1.7		9.0	9.0	6.31	12.74	19.34	26.10	33.02	40.12
1.8		9.7	8.4	6.65	13.44	20.39	27.51	34.81	42.28
1.9		10.3	8.0	7.00	14.13	21.44	28.92	36.60	44.45
2.0		10.8	7.4	7.34	14.83	22.49	30.34	38.38	46.61

④

**An example of heat balance**

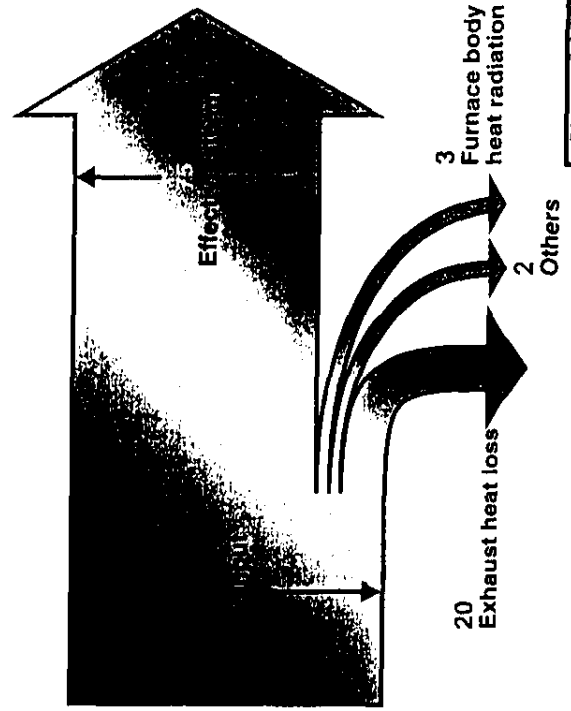

**Boiler efficiency = 75%**

④

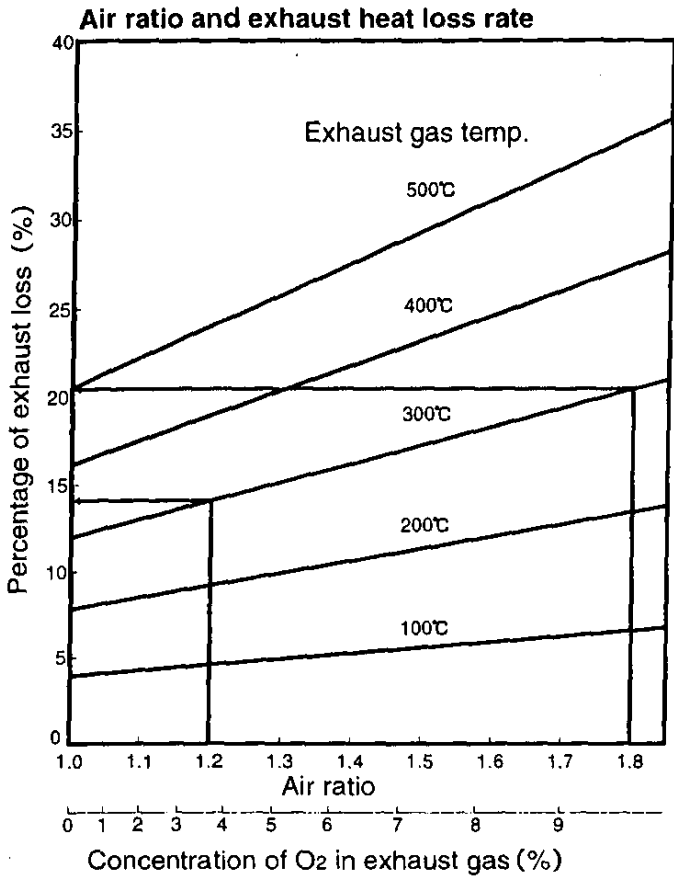

13

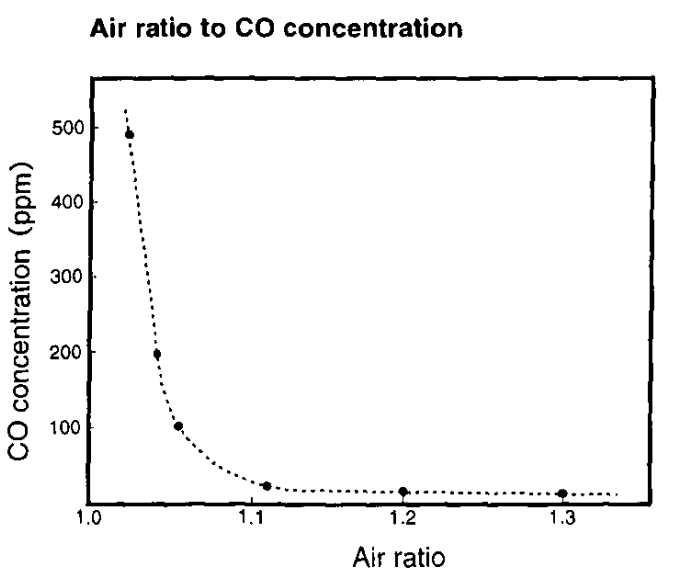

15

### Exhaust heat recovery

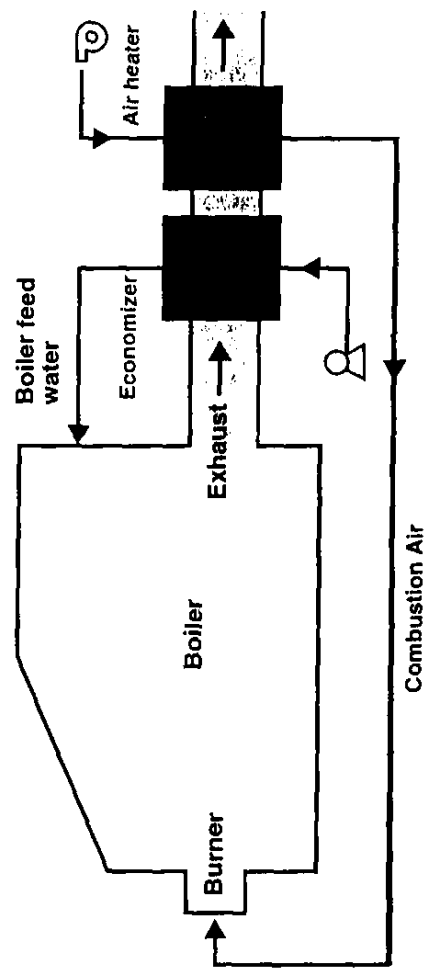

16

### Air ratio

$$m = \frac{\text{Actual volume of combustion air (m}^3\text{)}}{\text{Theoretical air volume (m}^3\text{)}}$$

$$= \frac{21}{21 - (\text{Percentage of O}_2 \text{ in the exhaust})}$$

### (Example)

Exhaust temp.	300°C
Air ratio	1.8 → 1.2
Exhaust heat loss	20% → 14%
Percentage of fuel conservation	33%

14

## Exhaust heat recovery

### ● Installation of an economizer

Difference in the feed water temp. at the inlet and outlet of the economizer  $\approx 7^{\circ}\text{C}$



1% of fuel conservation

### ● Installation of an air heater

Difference in the exhaust temp. at the inlet and outlet of the air heater  $\approx 20^{\circ}\text{C}$



Increase 1% in boiler efficiency

19

## SO<sub>2</sub> concentration in the exhaust gas and acid dew point

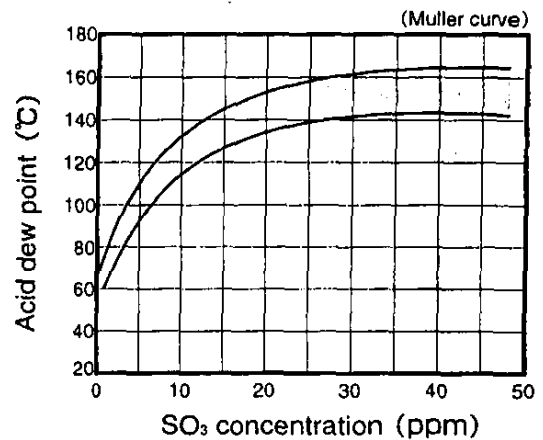

20

## Furnace body heat radiation loss

Radiation volume  $Q$  (kcal/m<sup>2</sup>h) through radiation from the furnace wall

$$Q = 4.88 \epsilon \left\{ \left( \frac{t+273}{100} \right)^4 - \left( \frac{a+273}{100} \right)^4 \right\}$$

$t$  : Furnace wall surface temp. ( $^{\circ}\text{C}$ )  
 $a$  : Air temp. surrounding the furnace ( $^{\circ}\text{C}$ )  
 $\epsilon$  : Furnace wall surface radiation rate

Percentage of radiation heat loss (at  $t - a = 28^{\circ}\text{C}$ )

Boiler capacity t/h	5	10	50	100
Percentage of radiation heat loss %	2.0	1.4	0.7	0.4

19

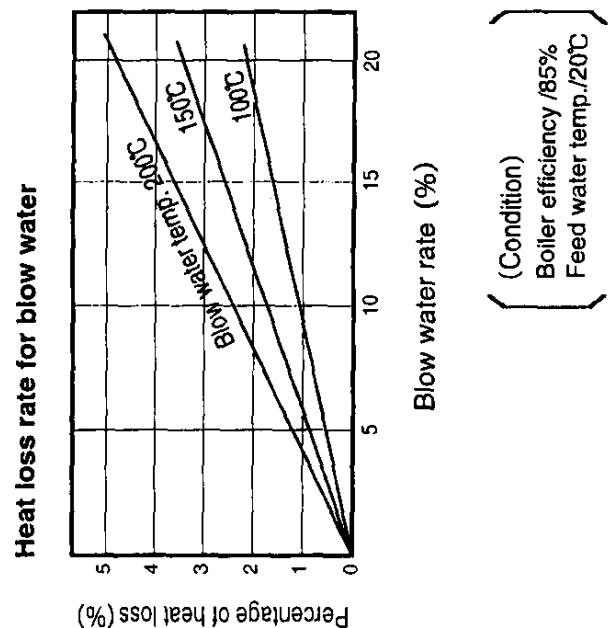

20

### 3. Energy conservation for steam systems

- ① Reinforcing the heat insulation
- ② Reducing the steam pressure
- ③ Preventing steam leakage

### Reinforcing the heat insulation

Example of installing the heat insulation for steam piping, valves and flanges

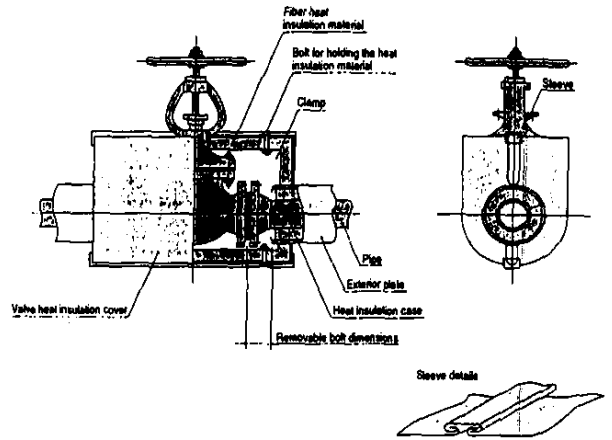

21

22

Equivalent Bare Piping (m) =  $\frac{\text{Valve Flange Surface (m}^2\text{)}}{\text{Bare Piping Surface (m}^2\text{/m)}}$

	25A	50A	100A
Flanged Glove Valve	1.22	1.40	1.58
Flanged Reducing Valve	0.53	0.44	0.39
Flange	225	700	75
Heat Loss kcal/h·m	35		
Heat Loss kcal/h·m 50mm insulation			

23

### Example of fuel conservation through heat insulation

Steam : 5kg/cm<sup>2</sup> saturated steam  
 Boiler : Operated 24 h/day X 350 day/Y = 8400 h/Y  
 Valve : 20 of 50A bare flanged glove valves

↓ Valves heat insulated

Yearly conservation volume ≅ 6,400 ℓ (heavy oil)

↓

Yearly conservation amount ≅ \$ 860

24

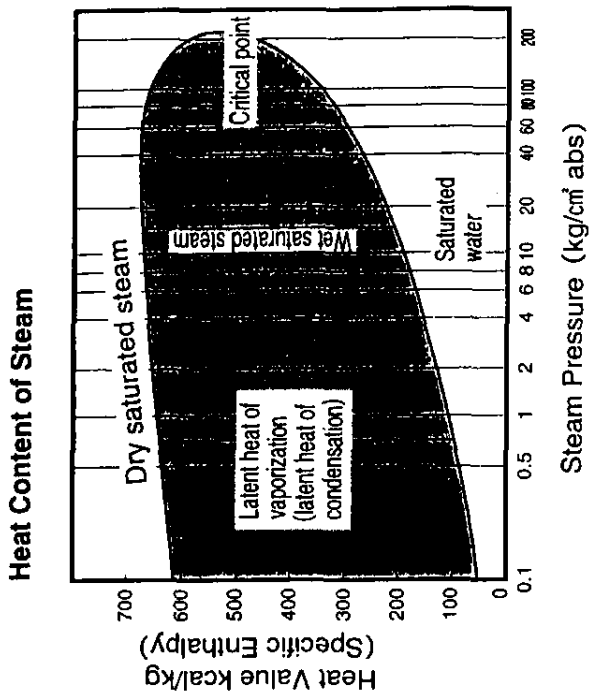

**Volume of steam leaking from small holes**

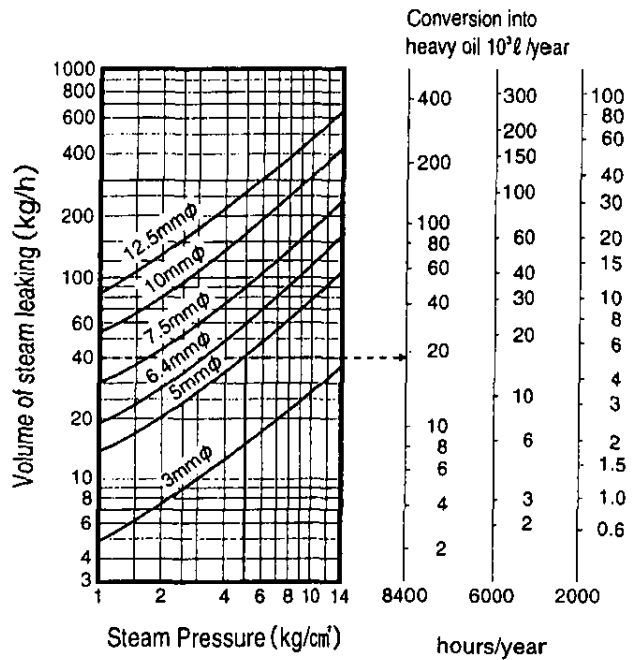

**Example of fuel losses due to steam leakage**

Steam : 5kg/cm<sup>2</sup> saturated steam  
 Boiler : Operated 24 h/day X 350 day/Y = 8400 h/Y  
 Steam piping : 5mmφ size holes



Yearly fuel loss volume ≐ 20×10<sup>3</sup> ℓ (heavy oil)



Yearly fuel loss amount ≐ \$ 2,700

**4. Conclusion**

- ① By installing a meter and measuring device, the heat flow and usage situation will be made grasped. = Heat management
- ② After determining the present situation, problems existing in the heat usage will be made clear.
- ③ An analysis will be made of the investment effects realized through improving the problems.
- ④ An effective energy conservation will be promoted.

**Example of the heat balance after carrying out energy conservation**

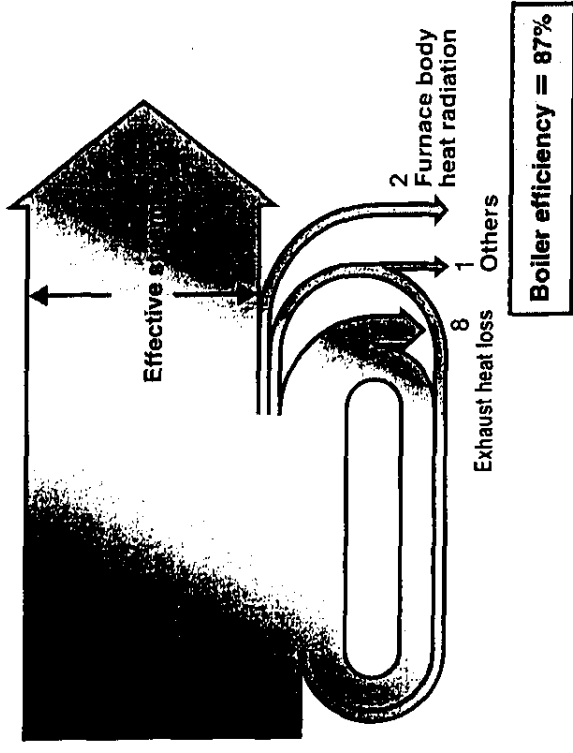

**Example of effects realized through energy conservation**

Boiler : Operated at 5 t/h, 8400 h/y, Exhaust temp. 300°C ( $O_2 = 9.7\%$ )



1. Fuel combustion improved ( $O_2 : 9.7\% \rightarrow 3.7\%$ )
2. Installation of exhaust heat recovery device (Exhaust temp. 300°C  $\rightarrow$  170°C)
3. Heat recovery of blow water
4. Insulated furnace wall, heat insulation

Boiler efficiency : 75%  $\rightarrow$  87%  
 Yearly fuel conservation amount  $\approx$  \$ 43,000